

LC-POWER™

USER MANUAL FOR
HIGH PERFORMANCE LIQUID COOLER

LC-CC-240-B
LC-CC-240-B-ARGB
LC-CC-280-B
LC-CC-280-B-ARGB
LC-CC-360-B
LC-CC-360-B-ARGB

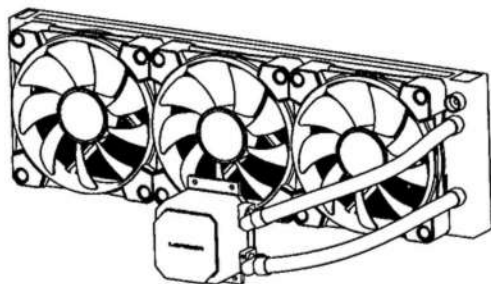

A Radiator + Pump + Fans
Radiator + Pumpe + Lüfter

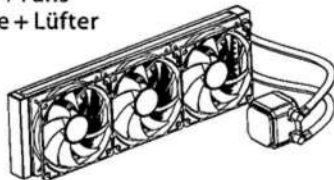

B Intel Backplate
Intel-Backplate

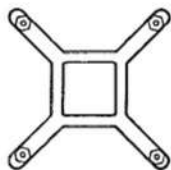

C Intel Backplate
Intel-Halterung



D AMD Bracket
AMD-Halterung

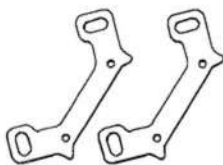

E Thermal Paste
Wärmeleitpaste



F Splitter Cable
Splitterkabel

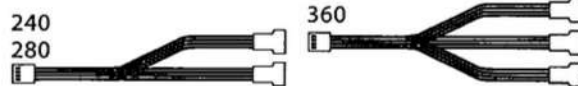

G1

Thumbscrew
Schraube



x4

G2

Intel 115X/1200/1700/1851
Standoff
Intel 115X/1200/1700/1851
Abstandshalter



x4

G3

Intel 2011 Standoff
Intel 2011 Abstandshalter



x4

G4

AMD Standoff
AMD-Abstandshalter

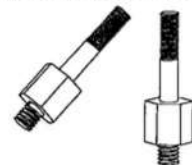

x4

G5

Bracket Screws
Halterungsschrauben



x4

G6

Radiator Mounting Screws
Radiator Befestigungsschrauben
240 - x8
280 - x8
360 - x12



G7

Fan screws
Lüfterschrauben
240 - x8
280 - x8
360 - x12



G8

Washers
Unterlegscheiben



x4

Step 1

Use the fan mounting screws to mount the fans onto the radiator.

Befestigen Sie die Lüfter mit den Lüfterschrauben am Radiator.

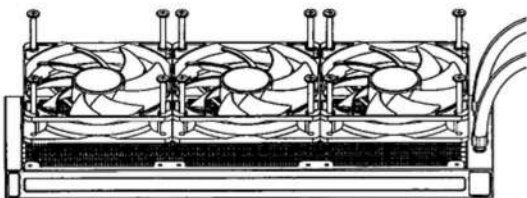
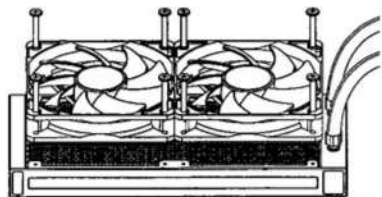
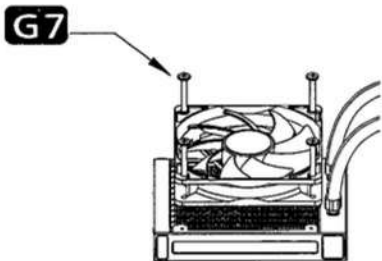

Step 2

Install the Intel / AMD bracket
Montieren Sie die Intel / AMD Halterung

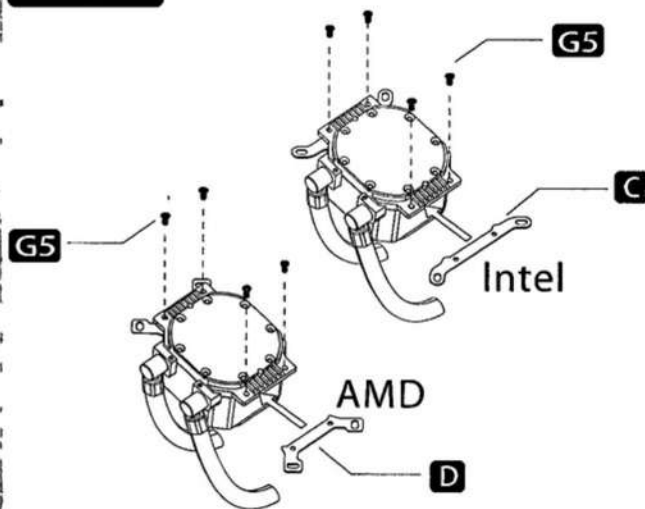

Remove the protection film and apply the thermal paste.

Entfernen Sie die Schutzfolie und tragen Sie die Wärmeleitpaste auf.

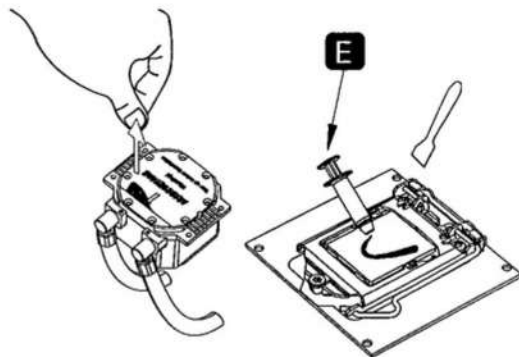

Step 3

For AM4 and AM5, the original AMD backplate is retained. Only the original bridges with the nose on the front of the mainboard are removed and then the cooling pump head according to the instructions.

The backplate (B) in the package contents is only for Intel CPU mounting.

Für AM4 und AM5 wird die Original AMD Backplate beibehalten. Es werden nur die Original-Brücken mit der Nase auf der Vorderseite des Mainboards entfernt und dann der Pumpenkopf der Kühlung nach Anleitung montiert.

Die Backplate (B) im Verpackungsinhalt ist nur für Intel CPU Montage.

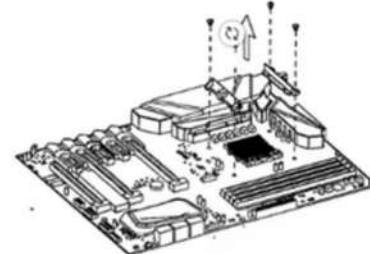

AMD
Intel

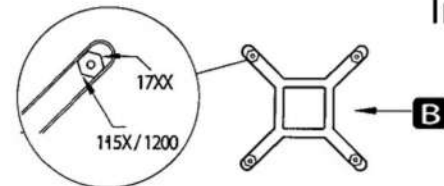

Choose the matching position and install the backplate on the back side of your mainboard.

Wählen Sie die passende Position und installieren Sie die Backplate auf der Rückseite Ihres Mainboards.

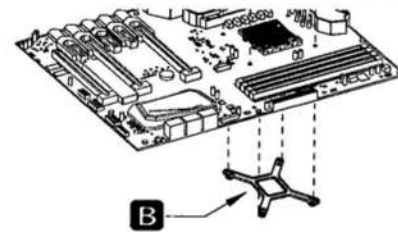

Install the standoffs on the front.
Place the pump with the bracket on the standoffs and tighten the thumbscrews diagonally.

Installieren Sie die Abstandshalter auf der Vorderseite des Mainboards.

Setzen Sie die Pumpe mit der Halterung auf die Abstandshalter und ziehen Sie die Schrauben diagonal an

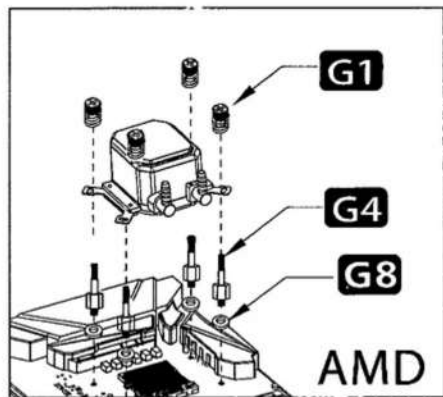
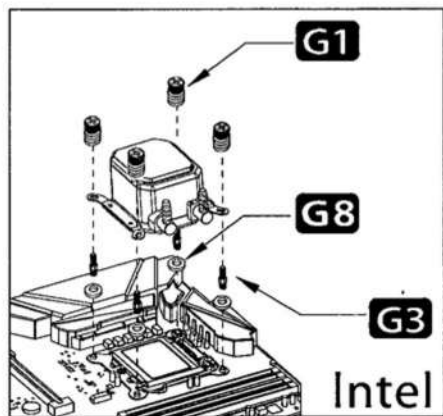

Step 4

Use the radiator mounting screws to mount the radiator to the case.

Nutzen Sie die Radiator-Befestigungsschrauben, um den Radiator am Gehäuse zu befestigen.

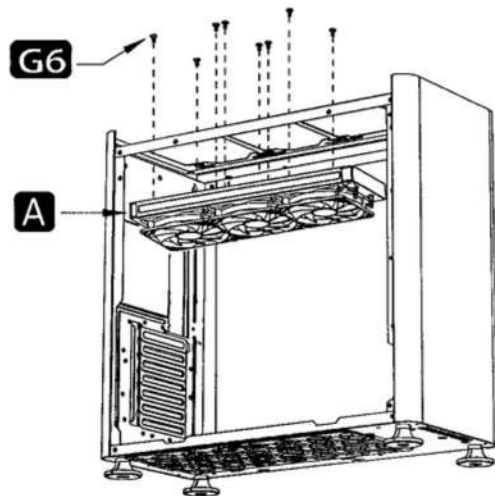

Step 5

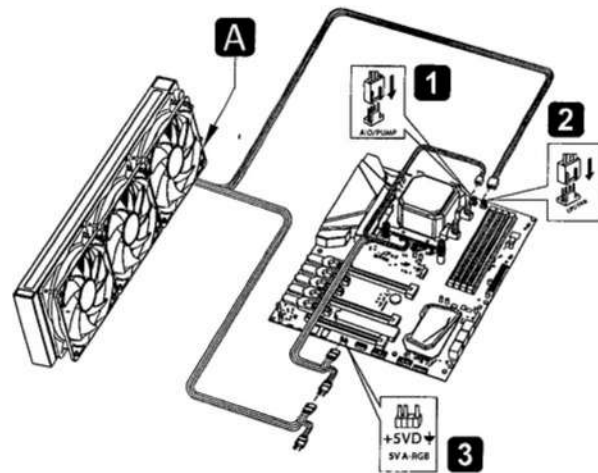

1. Connect the 3-pin connector of the pump to the AIO_PUMP header on the motherboard.

Verbinden Sie den 3-Pin-Stecker der Pumpe mit dem AIO_PUMP-Anschluss auf dem Mainboard.

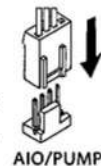

2. Use the splitter cable to connect the 4-pin PWM fan connectors with the CPU_FAN header on the motherboard.

Verbinden Sie die 4-Pin-PWM-Lüfterstecker über das Splitterkabel mit dem CPU_FAN-Anschluss auf dem Mainboard.

